

EXPERIMENTAL EVIDENCE OF ^4He PRODUCTION IN A COLD FUSION EXPERIMENT

ANTONELLA DE NINNO, ANTONIO FRATTOLILLO, ANTONIETTA RIZZO

ENEA - Unità Tecnico Scientifica Fusione
Centro Ricerche Frascati, Roma

EMILIO DEL GIUDICE
INFN Sezione Milano
Via Celoria 16, 20133 Milan (Italy)

GIULIANO PREPARATA
University of Milan, INFN Sez. Milano
Via Celoria 16, 20133 Milan, (Italy)



ENTE PER LE NUOVE TECNOLOGIE,
L'ENERGIA E L'AMBIENTE

Experimental evidence of ^4He production in a cold fusion experiment

ANTONELLA DE NINNO, ANTONIO FRATTOLILLO, ANTONIETTA RIZZO

ENEA - Unità Tecnico Scientifica Fusione
Centro Ricerche Frascati, Roma

EMILIO DEL GIUDICE
INFN Sezione Milano
Via Celoria 16, 20133 Milan (Italy)

GIULIANO PREPARATA
University of Milan, INFN Sez. Milano
Via Celoria 16, 20133 Milan, (Italy)

This report has been prepared and distributed by: Servizio Edizioni Scientifiche - ENEA
Centro Ricerche Frascati, C.P. 65 - 00044 Frascati, Rome, Italy

The technical and scientific contents of these reports express the opinion of the authors but not necessarily the opinion of ENEA.

EXPERIMENTAL EVIDENCE OF ^4He PRODUCTION IN A COLD FUSION EXPERIMENT

Riassunto

In questo lavoro viene dimostrata la simultanea produzione di eccesso di entalpia e di ^4He durante l'elettrolisi di acqua pesante su catodo di Palladio (Pd); quando il rapporto stechiometrico $x=[\text{D}]/[\text{Pd}]$ eccede la soglia critica $x=1$. Questo effetto è stato ottenuto su catodi resistivi quasi unidimensionali in forma di serpentina, ricavata da un film sottile di spessore tra 1 e 2 micron. È stata dimostrata l'influenza di un potenziale elettrico longitudinale applicato al catodo, sul raggiungimento di elevati caricamenti. L'eccesso di calore è segnalato da un aumento di temperatura, misurato mediante un elemento Peltier di tipo commerciale tenuto in buon contatto termico con il substrato del catodo in film sottile. Allo scopo di rivelare le piccole quantità di ^4He che ci si aspetta siano presenti, simultaneamente alla produzione di entalpia, come evidenza del carattere nucleare del processo, è stato messo a punto un metodo di analisi basato sulla totale rimozione di tutti i gas chimicamente attivi presenti nella miscela gassosa prodotta nel corso dell'elettrolisi. L'utilizzo di pompe "Non-Evaporable Getter" (NEG) permette di rimuovere efficacemente dalla miscela tutte le componenti non inerti, ed in special modo gli isotopi dell'idrogeno. I gas nobili che rimangono, soli, in fase gassosa vengono inviati periodicamente allo spettrometro di massa e qui analizzati quantitativamente. L'osservazione di una quantificabile trasmutazione di Deuterio in Elio prova univocamente che alla base del fenomeno della cosiddetta "fusione fredda" c'è un processo di natura nucleare. Dalla quantità di Elio prodotto nel corso dell'elettrolisi, in base alla conversione $2\text{D}\rightarrow^4\text{He}+23.8\text{ MeV}$, si può stimare l'energia prodotta nel processo. Tuttavia si trova che l'energia stimata attraverso questa conversione eccede quella valutata semplicemente in base all'aumento di temperatura. Questa discrepanza aumenta all'aumentare del livello di energia prodotto e può essere compresa considerando le condizioni di non equilibrio termico che si verificano nelle vicinanze del catodo e la conseguente perdita di calore per irraggiamento da parte della superficie calda del materiale Pd. Come caso estremo si può raggiungere la fusione parziale del catodo (la temperatura di fusione del Pd è di 1828 K) senza aumentare apprezzabilmente la temperatura dell'elettrolita e dunque senza che l'evento sia rivelato dal metodo calorimetrico. Il fenomeno descritto è stato riprodotto diverse volte: il livello quantitativo della produzione di elio nei differenti esperimenti, dipende, ovviamente, dal livello di caricamento di Deuterio in Palladio raggiunto nel corso dell'esperimento.

Abstract

We report the simultaneous production of excess enthalpy and of ^4He in a one dimensional Palladium (Pd) stripe cathode electrolytically loaded with Deuterium (D), occurring when the stoichiometric ratio $x=[\text{D}]/[\text{Pd}]$ exceeds 1. The excess heat is signalled by the local temperature rise, measured by a commercial Peltier element in good thermal contact with the thin film cathode substrate. In order to detect the very small amount of ^4He expected in the gas mixture exiting from the cell, we remove effectively all non inert components of the gas mixture (especially hydrogen isotopes) with a non-evaporable getter (NEG) pump. Noble gases remain in the gas phase and they are periodically analysed by the mass spectrometer. The observation of a sizeable transmutation of Deuterium into Helium proves unequivocally that a nuclear transmutation process is the cause of the so called "Cold Fusion". From the amount of Helium, under the assumption of the conversion $2\text{D}\rightarrow^4\text{He}+23.8\text{ MeV}$, one can estimate the produced power. We find that such power generally exceeds the one trivially estimated from the temperature rise. This mismatch is increasing with the produced power level and it is well understood by the non equilibrium thermal conditions in the immediate vicinity of the stripe and the consequent leakage of a major fraction of the produced heat by radiation. Indeed, further increasing the produced power, we have induced the actual melting of the thin cathode, proving that one has reached locally a temperature of 1828 K. The phenomenon has been reproduced several times: the quantitative outcomes of Helium in different experiments obviously depend on the level of Deuterium loading inside the Palladium matrix

Key words: Cold fusion, mass spectroscopy, non equilibrium calorimetry, nuclear reactions in condensed matter,

INDEX

1) INTRODUCTION.....	7
2) THE EXPERIMENTAL SETUP.....	8
3) RESULTS.....	14
4) CONCLUSIONS	19
ACKNOWLEDGEMENTS	19
APPENDIX A.....	20
REFERENCES	25

EXPERIMENTAL EVIDENCE OF ^4He PRODUCTION IN A COLD FUSION EXPERIMENT

1) INTRODUCTION

In March 1989 M. Fleischmann and S. Pons [1] reported that a sizeable excess of enthalpy, accompanied by a very tiny amount of radioactivity, had been detected in electrolytic cells with Palladium (Pd) cathodes during the electrolysis of D_2O , provided that the stoichiometric ratio $x=[\text{D}]/[\text{Pd}]$ of Deuterium in Pd had reached a critical threshold. This announcement sparked a good deal of controversy which convinced many established journals to neglect the topic altogether [2].

The main point at issue was that the claimed excesses of enthalpy were consistent only with a nuclear process (fusion of Deuterons) and that such a process at ambient temperature and without the emission of a commensurate number of neutrons was considered to be inconsistent with modern nuclear science. A possible theoretical understanding of the reported phenomenon was proposed by Bressani, Del Giudice and Preparata [3], just in the aftermath of Fleischmann-Pons announcement. We refer to Appendix A for a more detailed discussion of such a model. According to this model, ^4He should be expected to be the final product of this newly discovered form of nuclear fusion.

In the following years many reports of excess heat and Helium have been published, but so far no convincing experiment has been published, where the loading x , the excess heat and the Helium production are simultaneously measured as a function of short time intervals (less than 1 hour). An experimental programme aimed at probing the phenomenological

consequences of the above theoretical proposal has been launched at ENEA. The programme aims at the experimental demonstration that:

- i) an electric potential applied along a one-dimensional cathode (a wire or a deposited stripe) is able to depress the chemical potential of D in Pd (for $x > 0.7$) and enhance the rate of loading (Preparata effect) [4];
- ii) when x becomes larger than 1, excess heat is generated;
- iii) ^4He is simultaneously generated, commensurate with the level of the excess enthalpy.

The implementation of this programme has lasted a number of years and it has required solving many technological problems. In the present paper we report a first set of experimental results.

2) THE EXPERIMENTAL SETUP

A simplified block diagram of our experimental lay-out is shown in Fig. 1. It basically consist of a small (8.5 cm^3) electrolytic cell (Fig. 2a) whose electrodes, kept 5 mm apart, are an anode made of a Platinum sheet and a cathode made of a Pd stripe sputtered on an inert surface, wound in the so-called “bustrophedic”¹ geometry (Fig. 2b). The stripe is typically 100 cm long, 50 μm wide and 2 μm thick and, when empty, has an electrical resistance R_0 of about $3\text{K}\Omega$ at room temperature. The cell is filled with 5.5 ml of 10^{-4} M LiOD solution, having a conductivity of $104 \pm 1 \mu\text{S/cm}$. The electrical scheme of the experimental lay-out is given in Fig. 3.

The production of stable stripes has required considerable efforts. During the absorption of D, the lattice parameter increases by up to 10% of its length [5], inducing large stresses in the sample [6]. Suitable choices of the substrate, of the sputtering parameters and of the etching technique (used to pattern the film) have been necessary in order to achieve very robust cathodes, capable to survive several load/unload cycles at room temperature.

The amount of D loading is estimated by measuring the ratio of the electrical resistances R/R_0 (where R_0 is the resistance of the empty palladium matrix) which is related to the loading

¹ Bustrophedic means the geometry of the furrows cut in the ground from the plough driven by an ox (from west to east and from north to south)

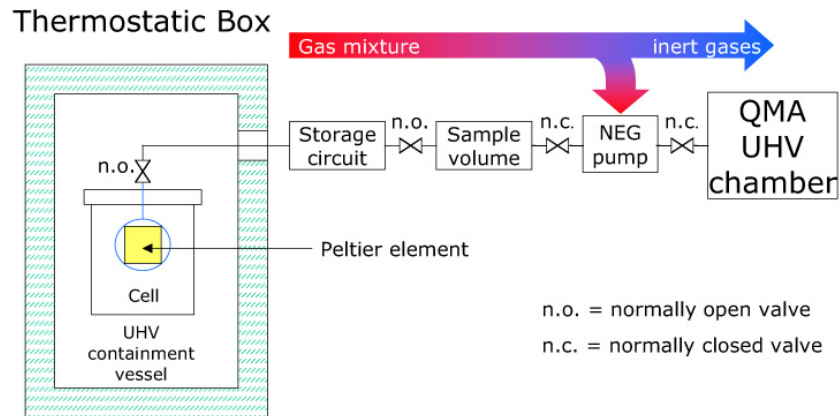

Fig.1 - Principle diagram of the cell and of the helium sampling circuit. The cell is enclosed in a ultra high vacuum (UHV) containment vessel and kept in thermal contact with a Peltier element. The cell is located inside a box, thermo-regulated within ± 0.01 °C. Gases from the cell are collected inside a storage volume. A fraction of the gas mixture (sample volume) is periodically sent to the NEG pump and then to the quadrupole mass analyzer (QMA). The non evaporable getter (NEG) pump, removes to a high degree all non inert components of the gas mixture (especially hydrogen isotopes).

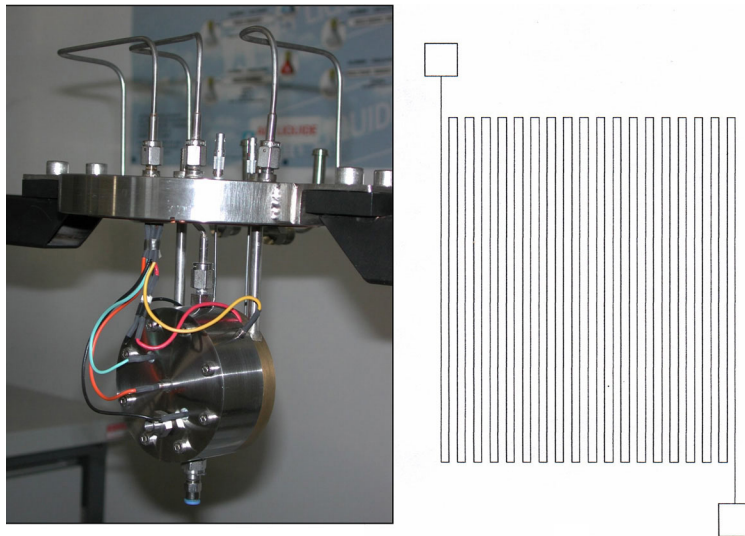

Fig. 2 - a) View of the electrolytic cell; b) sketch of the one dimensional (bustrophedic) cathode.

through a well known relationship, verified for a homogeneously loaded sample [7]. Differences between the measured maximum value of R/R_0 and the value given in the literature are probably due to a non homogeneous deuterium concentration along the sample.

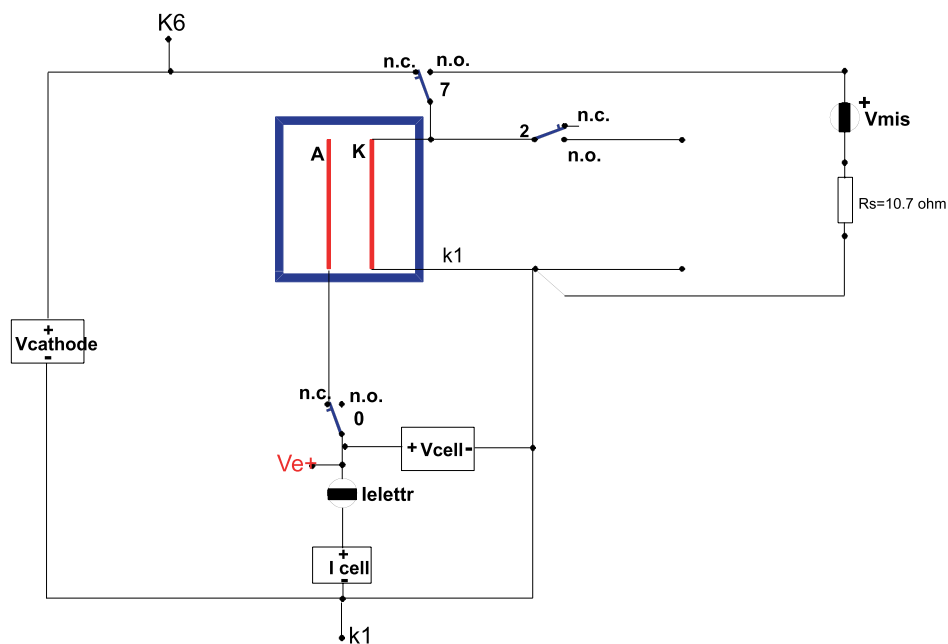

Fig. 3 - Electrical layout of the experiment. In order to perform the resistance measurement, electric switches exclude the electrolytic current during the DC resistance measurement.

The thin film cathode substrate is kept in good thermal contact with a commercial Peltier element. During a calibration we have obtained a linear relationship between the power dissipated in the cell and the voltage displayed across the contacts of the Peltier element. Heat dissipated in the cell produces an increase of the temperature of both the electrolyte and the electrodes: the proportionality factor between the power dissipated and the temperature (voltage) increase is 17.3 ± 0.3 mW/mV.

The gas mixture flowing from the cell contains mainly O_2 and D_2 with a very small amount of 4He . In such conditions, the Helium peak separation by mass spectrometry is not easy, since the e/m values of D_2 and 4He are very near to each other. In order to reduce such a large background signal we have introduced at the exit of the cell a non evaporable getter (NEG) pump, in order to remove to a high degree all non inert components of the gas mixture (especially hydrogen isotopes). Obviously, all inert gases are preserved. We have found necessary to avoid the use of cryosorption pumps, since they have been found to trap Helium erratically in the condensate.

During the measurement, the gas is periodically sampled, without influence on the electrolytic process.

According to recommended practice, the high resolution Quadrupole Mass Analyzer (QMA)

has been carefully calibrated with pure N_2 , Ar, 4He and D_2 . Specific 4He and Ar calibrations have been carried out statically (“pseudo-static” method), introducing known amounts of gas in the analyzer. The pressure inside the analysis chamber has been monitored by the same ion gauge used for dynamic calibrations, in order to compare the results. The two methods exhibit an excellent agreement.

As already pointed out, getter pumps ensure that virtually all the Deuterium initially present in the gaseous mixture is removed. The absence of a dominant Deuterium peak, which is however well resolved by the mass spectrometer, improves considerably the ultimate sensitivity to 4He . Checks with 4He - D_2 mixtures (about 67% - 33% and 50%) have been performed. The partial pressures of the two components have been calculated by dividing the intensities of the two peaks (after the subtraction of cross contributions) by the corresponding sensitivity for the pure gases, and accounting for the relative sensitivity of the hot cathode ion gauge (a conversion factor 6 for 4He and 2.6 for D_2). Measured concentrations are in good agreement with nominal compositions.

The experimental setup has been extensively calibrated throughout the last two years. The facility provides reliable and precise measurements of the content of inert components in any gas mixture. Figure 4 is a typical residual spectrum of an air sample. All non inert components have been removed effectively in just a few tens of seconds. A mixture with a known composition (82% 4He - 13.5% N_2 - 4.5% CO_2) has been used for quantitative tests. Samples of the mixture were introduced at different pressures in the analyzer, according to the pseudo-static method. The 4He concentration in the mixture samples was measured to be $86.5 \pm 0.6\%$, in reasonable agreement with the nominal value, taking into account that the procedure used to fill the sample volume, through a metering valve and a capillary tube, unavoidably gives rise to some helium enrichment of the mixture downstream. The linear fit of the experimental data (Fig. 5) shows the very high precision of the measurement.

A “memory effect” has also been detected. When pure helium or the above mentioned mixture sample are admitted to the analyzer, the ion current at mass 4 suddenly rises as expected to a rigorously constant value. A different behavior is instead observed with air samples. After the initial step, the ion current at mass 4 begins to slowly increase with time. Similar effect is not exhibited by the Argon signal.

This effect is reduced significantly soon after baking of the QMA ultra high vacuum (UHV) chamber; it then appears again and becomes more and more evident (Fig. 6) as the experiments proceed. This fact obviously suggests that 4He is to some extent adsorbed on the walls of the analysis chamber and successively released.

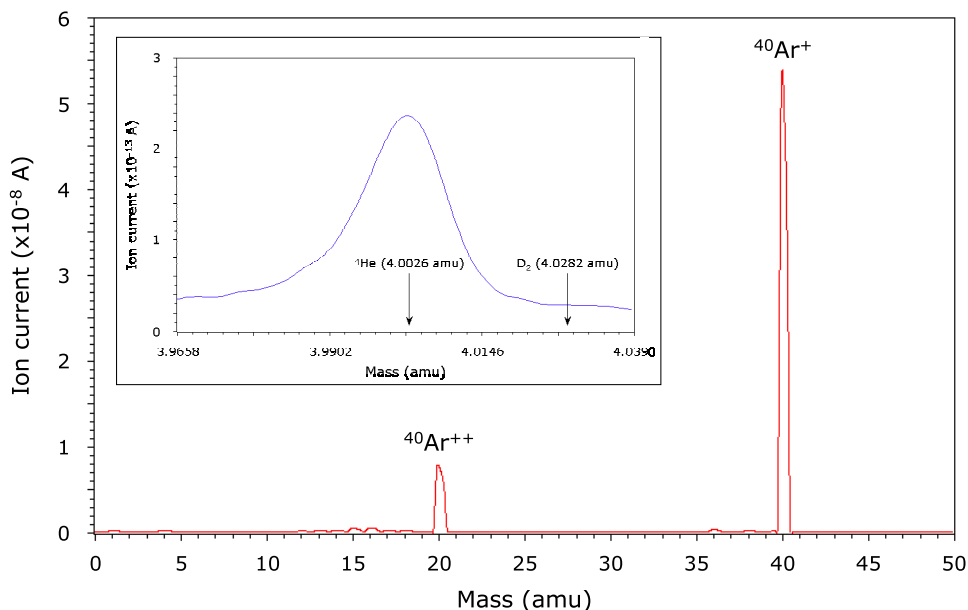

Fig 4 - Typical residual spectrum of an air sample. Getter pumps effectively remove non inert components. Noble gases are preserved as shown by dominant peaks of Ar^+ (mass 40) and Ar^{++} (mass 20). The high resolution insert shows that also ^4He is preserved, while D_2 has been completely removed.

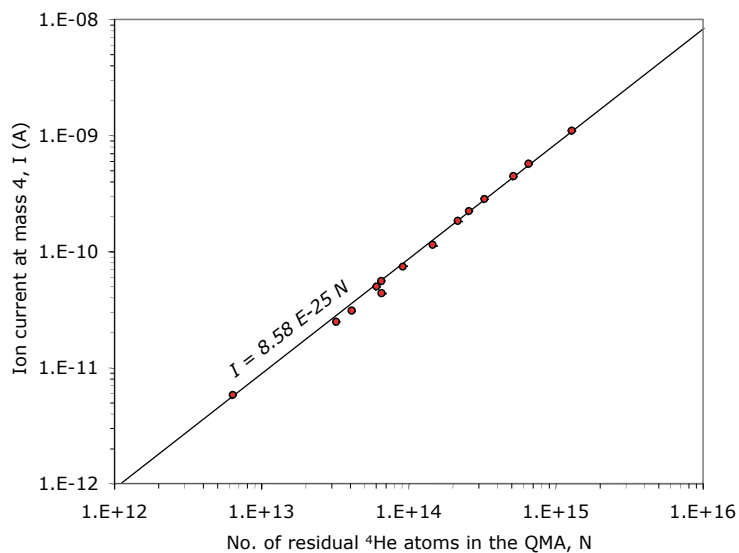

Fig. 5 - In order to test the performance of the system we measured the helium content of a gas mixture having a known composition. The high quality of the linear fit accounts for the very high precision of the measurement. The quantitative agreement between the measured and the nominal contents accounts for the accuracy of the measurement (see details in text).

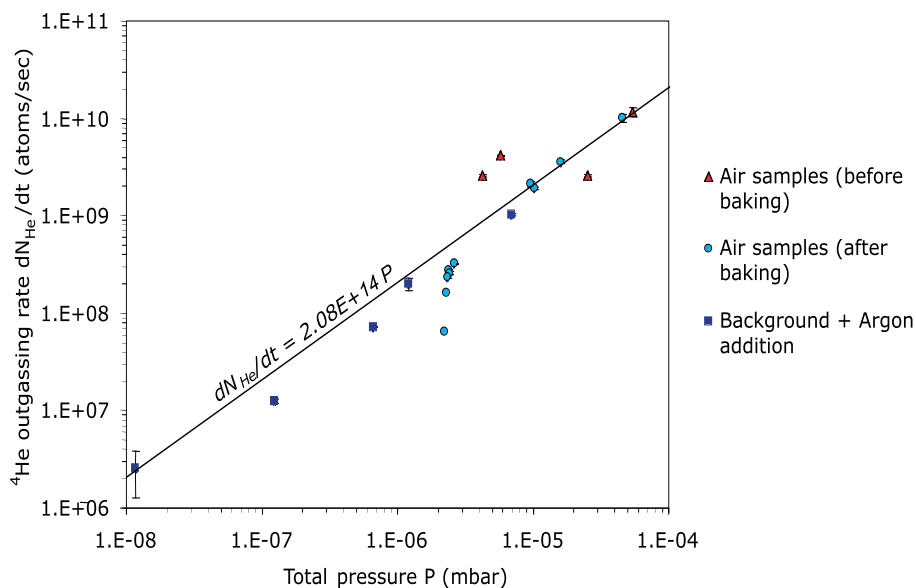

Fig. 6 - Helium atoms are stripped from the vacuum chamber walls due to the ion bombardment by other species. We have measured the ^4He outgassing rate versus the total pressure in the analysis chamber. The outgassing, which is very small soon after the baking of the vacuum system, becomes significant after some measurement. This effect must be accounted for during the elaboration of the experimental data.

We have suspected that the co-presence of a much larger amount of Argon, during air tests, is responsible for this effect, due to the bombardment of the walls by the Argon atoms. We have checked this hypothesis, by injecting increasing amounts of Argon into the chamber, under pseudo static vacuum condition. The results are plotted again in Fig. 6. It is quite evident that the outgassing rate increases linearly with the Ar pressure. The occurrence of this phenomenon may somewhat affect the results of the analysis, and must be accounted for, in order to not overestimate the Helium content. It can be reduced considerably by regularly baking the UHV chamber.

The electrochemical cell is connected to the analyzer through a storage circuit (Fig. 1), purposely designed to allow for on line analysis of the evolving gases. The whole circuit has been built up using UHV components. Care is taken in order to prevent any possible helium contamination. Before starting an experimental run, both the cell and the circuit are first evacuated and tested against leaks, then purged and finally buffered with high purity N70 Nitrogen (99.99999%). The cell is then filled with the electrolyte taking all precautions in order to avoid air contamination. Furthermore, the cell is enclosed inside an UHV containment vessel, which is subjected to the same initial testing and purging procedure and is finally filled with N70 nitrogen at about 1050 mbar to prevent helium permeation from the surroundings. Buffering of the cell and of the sampling circuit has been found to be necessary to prevent boil off of the liquid electrolyte during the experiment. Due to the ≈ 10 ppbV

content of ^4He in the high purity nitrogen, the background in the analyzer is set to about 10^{12} atoms. A sample of the N70 nitrogen buffer, however, is analyzed at the end of the preliminary purging procedure (just before starting the electrolysis) to set the zero of each experimental run. All operations, from initial purging to sample drawing and analysis, are carried out with an automatic sequence, in order to ensure a perfect reproducibility of the whole process. Relevant parameters are logged on a PC.

The gases evolving during the experiment are collected in the storage volume, which is held at a constant pressure (1050 ± 2 mbar). A 6.29% aliquot of this gas (sample volume of Fig. 1) is periodically sent to the NEG pump and then to the QMA to be analysed. This procedure provides a precise measurement of the number of ^4He atoms contained in the gas mixture. Since equal quantities of gas are extracted at each sampling, it is very easy to compare, time by time, the results of the analysis. The increment of the number of ^4He atoms divided by the time elapsed between two successive analysis give us an estimate of the Helium yield, and hence of the excess power. The particular procedure adopted in the present configuration eliminates the need to refill the system with pure N_2 after a sample has been extracted, thereby also eliminating any perturbation of the electrolytic experiment as well as any alteration of the gas mixture composition.

3) RESULTS

Out of many measurements, we report here the preliminary results obtained in the last experimental campaign. Results of the previous campaign have been analysed and are in good qualitative agreement with the results reported here.

The sequence of the different steps in a typical experiment is given in Figs. 7,8 and 9.

1) Preloading phase. A feeble electrolytic current, about 5 mA, is made flow though the cell. In a time of about one hour, R/R_0 reaches smoothly the peak value of 2 corresponding, according to Figure 4a, to the value $x=0.7$ (beta phase). This state is an equilibrium phase and it may be continued indefinitely. During this phase the output power P_{out} coincides with the power P_{in} supplied by the electrolytic current and the number of ^4He atoms is compatible with the background value of the detector. At this moment the cold fusion phenomenon is absent and these measurements exclude the existence of systematic errors or artefacts.

2) Loading phase. At this point we apply a voltage V_c along the cathode. This voltage is applied by increasing proportionally the cell current to a value ranging from 10 to 40 mA (corresponding to a current density ranging from 20 to 80 mA/cm²). When the cathode is a

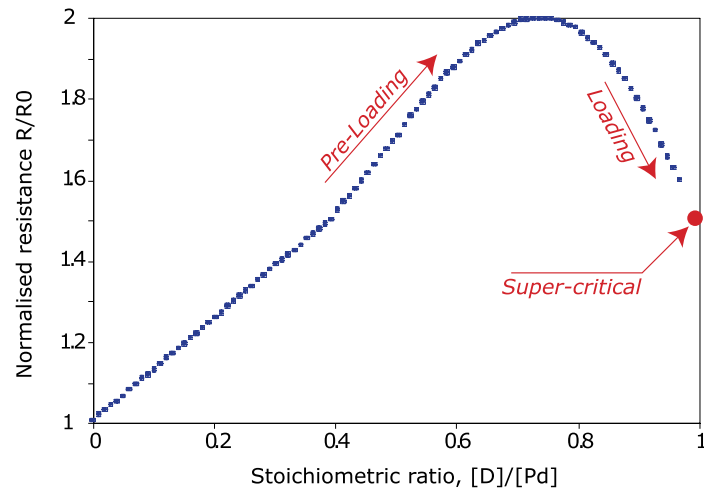

Fig. 7 - R/R_0 versus the stoichiometric ratio x (data from reference 6). This graph allows us to derive the value of x from the electric resistance of the cathode.

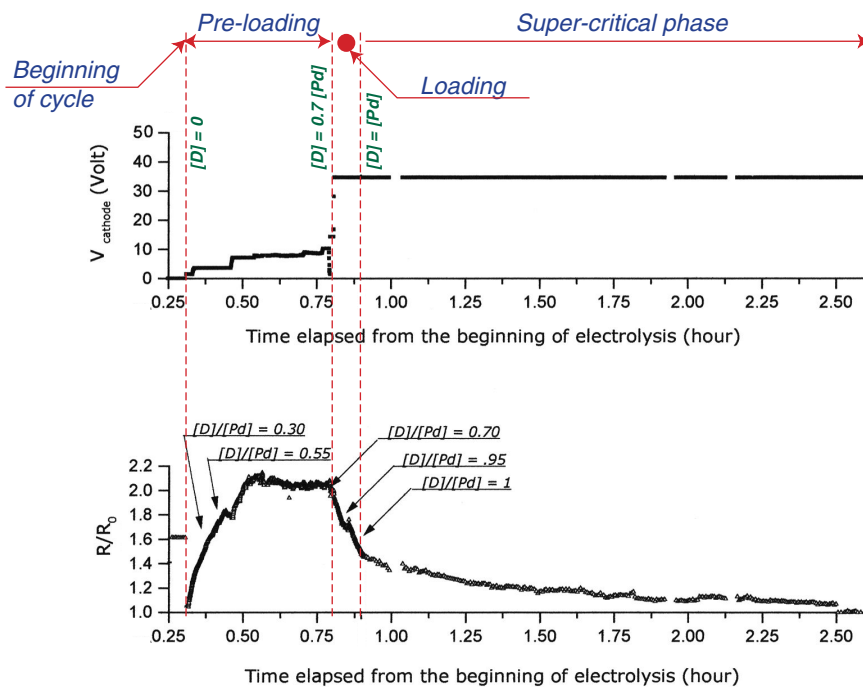

Fig. 8 - Influence of $V_{cathode}$ on the Pd loading (Preparata effect). In the pre-loading phase small values of electrolytic current, and hence of $V_{cathode}$, are used to drive the system to the β -phase equilibrium ($x = 0.7$). The resistance R/R_0 increases from 1 to 2, where the loading stops. At this point $V_{cathode}$ is augmented and R/R_0 falls off abruptly, signalling a further increase of x (loading phase). When x crosses 1 the system enters the super-critical phase.

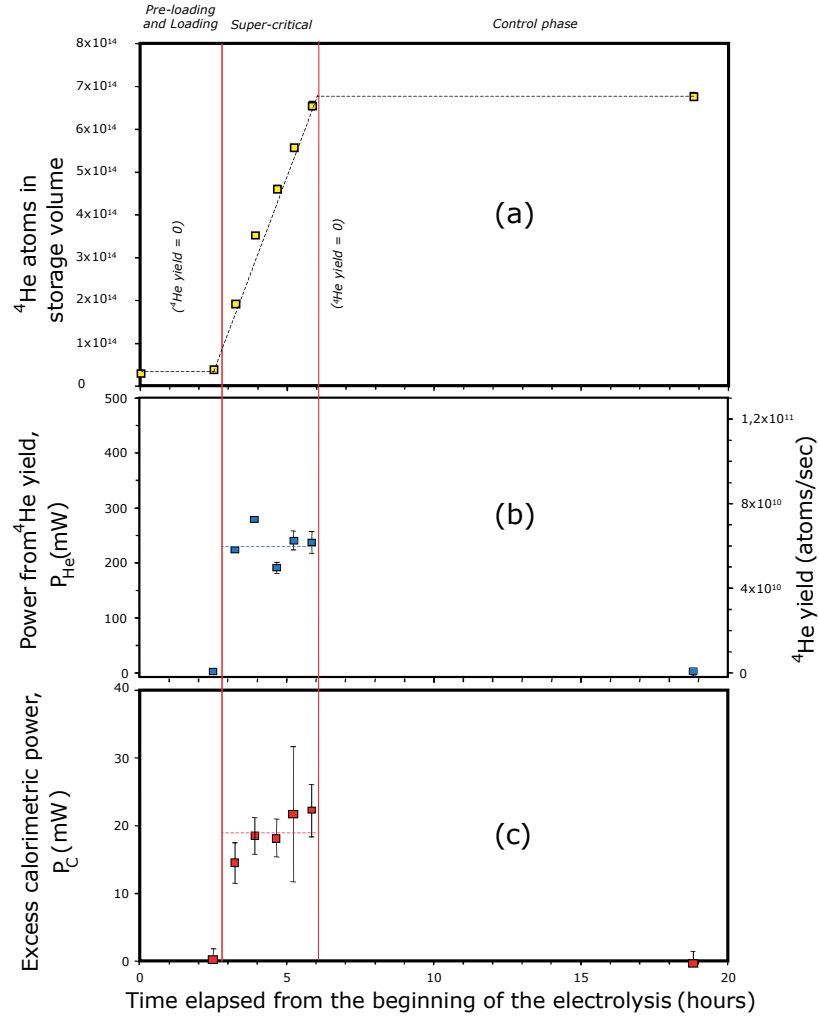

Fig 9 - a) ^4He content of the gas mixture inside the storage volume, (b) excess power P_{He} derived from helium yield and (c) average excess calorimetric power P_c in the experiment described in the text as case 1. The data are shown as a function of time allowing to check the coincidence. During the pre-loading and loading of the cathode, we do not observe any anomaly. When the system is driven over the threshold $x = 1$, entering the super-critical phase (see text), an increase of both P_c and P_{He} is observed. About 12 hours after the switch-off of the electrolytic current both P_c and P_{He} are zero.

plate, such current densities are unable to increase significantly the value of x , at least in a time of some hours. When, on the contrary, the cathode is a narrow and thin stripe, as in our case, R/R_0 drops in a very short time (some minutes) from 2 to about 1.4, as exhibited in Fig. 8. In order to verify that indeed we are past the maximum of Fig. 7, we switch off for a short time the current, producing a small, temporary Deuterium unloading of the cathode, with an observed increase of R/R_0 (rather than a decrease). The value $R/R_0 = 1.4$ corresponds to $x \approx 1$ (see Fig. 7).

3) *Supercritical phase*. Upon crossing this threshold, “anomalies” appear in the system, namely (Fig. 9):

i. A significant deviation of ^4He from the baseline is observed from the first time interval of 40 minutes onwards. The ^4He content continuously grows, as long as the system is in the supercritical phase.

ii. The temperature of the cathode, as measured by the Peltier element, increases above the previous equilibrium value, signalling a source of enthalpy in the cell.

The two above anomalies, within the respective typical response times (40 min. for ^4He and about 300 sec. for the Peltier system) occur simultaneously. From the amount of Helium, under the assumption of the conversion $2\text{D} \rightarrow ^4\text{He} + 23.8 \text{ MeV}$, one can estimate the produced power. We find that such power P_{He} generally exceeds the power P_c trivially estimated by the Peltier system. This point will be better elucidated further on.

4) *Control phase*. After some hours of cell operation, the cathode potential V_c is switched off: both anomalies i) and ii) disappear, i.e. P_{He} and P_c settle back to the initial zero value. Soon after the switch-off, the loading x drops below the threshold and P_c falls to zero within the time constant of the Peltier transducer. After 12 hours, a check of the ^4He content inside the storage volume shows that no further changes have occurred, excluding leakage or permeations.

We now describe separately three experimental cases:

Case 1 – Fig. 9. In this run $P_c \approx 19 \text{ mW}$ and $P_{\text{He}} \approx 240 \text{ mW}$. This huge mismatch ($P_{\text{He}} \approx 12.3 P_c$) suggests that most of the heat has been missed by the Peltier element.

Case 2 – In these experiments we were not able to reach a loading higher than $x=1$, thus we obtained only low values of the excess power (ranging from 5 to 10 mW). In this case $P_{\text{He}} \approx P_c$, with little or no mismatch.

Case 3 – Fig. 10. While in the supercritical phase, with a Peltier reading of $P_c \approx 20 \text{ mW}$, the cathode suddenly melted. The electric parameters (current and voltage) measured during this run did not account for an electrical cause of the melting; furthermore, as seen in Fig. 10, the extended damage in many separated subsections makes unlikely the hypothesis of a melting due to Joule effect. The melting occurred where the potential V_c was most negative and then, according to the Preparata effect (see the Appendix A), the cathode most highly loaded. The molten section accounted for the 5% of the total volume. The accident of the “molten” cathode provides evidence that at high temperature the bulk of the excess energy escapes the thermal calorimeter as has been suggested above.

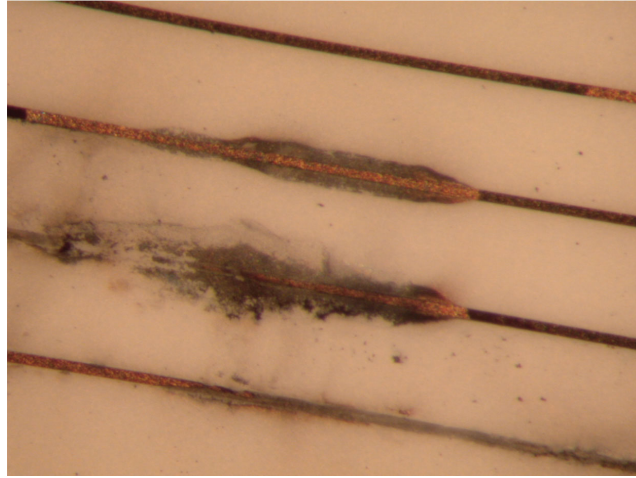

Fig. 10 - Picture of a cathode molten during an experimental run. The electric parameters (current and voltage) measured during this run did not account for an electrical cause of the melting; furthermore the extended damage in many separated subsections makes unlikely the hypothesis of a melting due to Joule effect.

The measurement of P_{He} is by far a more reliable measurement of the power produced in the supercritical phase, while the Peltier element is providing only a qualitative indication of the excess enthalpy, as discussed in the Appendix A. Case 3 proves that huge temperatures have been produced somewhere in the stripe, the melting point of Pd being as much as 1828 K. At such temperatures, the dominant channel of heat dissipation is Stefan-Boltzmann radiation, which is obviously only poorly recorded by the simple Peltier device. The melting interests about 5% of the stripe, for which the radiated power will be as much as 3.15 W! This description is further confirmed by the other measurements. In Case 2 — at very low power (10 mW) as measured by the Helium yield and therefore at small peak temperatures — there is good agreement $P_{\text{He}} \approx P_c$ while, in Case 1, at a higher power (240 mW) and hence at much higher peak temperatures, the discrepancy is apparent.

Therefore this mismatch is increasing with the produced power level and it is well understood by the non equilibrium thermal conditions in the immediate vicinity of the stripe and the consequent leakage of a major fraction of the produced heat by radiation.

The huge difference in cold fusion yields in these three cases, suggests that it is a rapidly varying function of x above the threshold.

A definitive check of this phenomenology will be performed in the near future by observing directly the radiation emitted by the supercritical stripe, for instance with help of an Infrared (IR) camera.

4) CONCLUSIONS

The experiments performed so far suggest the following conclusions:

i) The Preparata effect has been experimentally validated beyond any doubt: in every experiment we have been able to produce the results illustrated in Fig. 8. These results provide simultaneously a) evidence that deuterons are in a coherent state (see Appendix A), b) a very effective method of loading one-dimensional cathodes.

ii) The reported production of excess heat and Helium occur above a critical threshold of D concentration in Pd. The observed threshold is compatible with the value $x = 1$ predicted by the theory (see Appendix A) [3,8].

iii) The presence of ^4He provides evidence that a nuclear process occurred in the cell; a nuclear reaction has been obtained with purely chemical procedures.

P_{He} observed in Case 1 is compatible with the values of excess heat reported by Fleischmann [9] and by Preparata [10], with a highly reliable "isoperibolic" calorimetry.

In the next stage of the experiments we will try to improve the thermal calorimetry with the help of an IR camera, capable to detect the local temperature of the hot spots of the cathode. Furthermore we will search for possible new nuclear species produced by the very high frequency EM field associated to coherent nuclear processes subsequent to the $2\text{D} \rightarrow ^4\text{He}$ transmutation. There is preliminary indication [11] that Ni nuclei may be present in cathodes, subsequently to cold fusion.

ACKNOWLEDGEMENTS

We thank Carlo Rubbia whose contribution has been essential for achieving these results. We thank also Martin Fleischmann, Giuliano Mengoli and Getullio Talpo for their encouragement and the many fruitful discussions about electrochemistry and QED. We are grateful to Francesco Scaramuzzi who initiated Cold Fusion research at ENEA. Our thanks to Mr. Fabrizio Marini and Ms. Miriam Veschetti for their valuable technical help during both the preparation and the conduction of the experiments.

APPENDIX A

The above results fit quite well into the theoretical proposal [3] based on standard Quantum Electrodynamics (QED) [8]. We summarize here its main predictions:

- i) when the stoichiometric ratio $x = [D]/[Pd]$ exceeds 0.7 (at room temperature) D nuclei (deuterons) enter a stationary coherent oscillatory state, whose phase is sharply defined. This state is described by a unique wave function and is able to respond to externally applied electric potentials (and not only to their gradients)
- ii) when x exceeds 1, the probability that oscillating deuterons reach a distance that might allow the fusion becomes appreciable. As a matter of fact this threshold is not easily reached and this accounts for many of the failures in trying to reproduce the effect.
- iii) the fusion among deuterons occurs in a plasma within a medium and not in vacuo. Thus energy and momentum can be shared among many components of the condensed system, allowing in principle a fast cooling of the “hot” D-D compound nucleus preventing its splitting. Consequently ${}^4\text{He}$ should be expected to be the final product of this newly discovered nuclear fusion.

In order to understand the correspondence between our results and the theoretical proposal, we summarize our understanding of the physical system, a Pd metal matrix electrolytically loaded with H(D).

It has been known [12] for several decades that a Pd lattice can adsorb H_2 (D_2) molecules at atmospheric pressure, increasing their density by a factor 1000. Furthermore, as Alfred Cöhn discovered in the 30 s' [13], H (D) exists in the Pd lattice in the ionic form; its electron is transferred to the Pd electron bands. As a matter of fact, the transition of the D_2 molecule from the initial gaseous state to the final ionised state requires the crossing of an energy barrier of about 30 eV, a huge value indeed in the framework of the conventional chemical-electrostatic interactions. The phenomenon of the ordinary loading has been quite mysterious so far, at least in the frame of the generally accepted theories of the solid state. However, it has been shown [14] that coherent QED can explain the ionization of the D_2 molecule by virtue of the strong electromagnetic fields, acting inside the Pd lattice, produced by the coherent oscillations of the Pd electrons. Nuclear processes have never been observed at ordinary loading (namely when $x < 0.7$).

On the other hand it has also been shown [15] that at high loading ($x > 0.7$), H's enter a new configuration, characterised by a shift from the localized state of the β -phase to a state where H nuclei perform wide oscillations inside shallow potential wells. This feature suggests the

existence of a new phase (sometimes named the γ -phase). Other discontinuities in some physical variables (Hall coefficient [16], magnetic susceptibility [17] and electrical resistance [7]) point to a structural change occurring in the Pd lattice at $x \geq 0.7$.

The existence of a threshold in the D concentration which has to be overcome to observe the anomalies related to the so-called “cold fusion”, is a significant prediction of the QED coherence [3]. We are then able to understand why cold fusion experiments are sometimes non reproducible [18], given the difficulty in driving the system over the threshold using subtle electrochemical and metallurgical procedures.

The analysis of D/Pd systems in this new theoretical framework has suggested a new mechanism able to “overload” the Pd lattice with D^+ nuclei. A quantum system, whose dynamics is described by a unique wave function, is able to “see” the electrostatic potential applied to a Palladium wire as a chemical potential that confines the D^+ s in the lattice, thus increasing the achievable concentration (Preparata effect) [19]. This effect is analogous to the well known Böhm-Aharonov effect [20] where the dynamics of a quantum system are affected by a change in the e.m. potential through a modification of the phase of the wave function.

The chemical potential μ of $H^+(D^+)$ in Pd is thus shifted by the applied electric potential $V(\vec{r})$ multiplied by the screened charge Z^*e of the $H^+(D^+)$ in Pd

$$(A1) \quad \mu [V(\vec{r})] = \mu [0] + Z^*eV(\vec{r})$$

In eq. (A1) $\mu [0]$ could be taken as the chemical potential of the point 0 of the cathode where the electric potential is highest, so that V is the (negative) relative potential of the point \vec{r} with respect to 0. The profile of the chemical potential μ is changed in such a way that the chemical potential in some regions of the cathode can fall below the chemical potential μ_{sol} of the ions in solution. Consequently an inflow of ions occurs in those regions.

The Preparata effect will be most effective when it is possible to apply large electric potential differences across the cathode without inducing sizeable Joule heating that might spoil the precondition of the effect, i.e. the $H^+(D^+)$ coherence. The optimal effect is expected in one-dimensional cathodes whose resistance

$$(A2) \quad R = \rho \frac{l}{S}$$

is increased as much as possible by taking a large length l and a very small cross-section S . Since the expected height of the chemical potential barrier is a fraction of one eV and Z^* has been estimated [12] as about 0.1, a voltage of about 10 V applied along the one-dimensional cathode should be sufficient to induce a massive inflow of ions increasing the loading by a factor 1.3-1.4 with respect to a two or three dimensional cathode (plate or rod) exposed to the same electrolytic current density.

Let us now define the dynamics that allows two D^{++} 's to fuse .

The nuclear fusion problem can be treated in two steps : namely a) the Coulomb barrier problem; b) the nuclear interaction problem.

A.1 The Coulomb barrier problem

The positive charge of the nuclei is responsible for the Coulomb repulsion generating an energy barrier increasing with the product of the charges. In vacuo such a barrier can be overcome by the kinetic energy of the fusing projectiles.

In the DD fusion in vacuo the observed processes are:

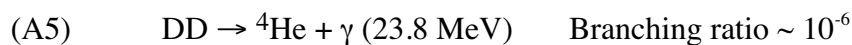
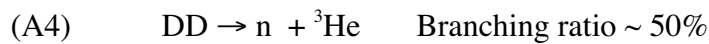

The widespread assumption of Asymptotic Freedom (namely, that microscopic components of a system can be considered free when their wavelength is much smaller than the typical space scales of the system) has convinced most scientists that at the very tiny kinetic energies of D 's at room temperature nuclear fusion is impossible, because of the height of the Coulomb barrier. A detailed analysis of D/Pd plasmas [8] , in the frame of coherent QED, however leads to a re-evaluation of the Coulomb barrier which turns out to be smaller than in vacuo, because of the high concentration of the negative charge due to the coherent plasma of electrons in Pd. The decrease of the barrier width from a few Å to about 0.1 Å, magnifies the fusion probability by about 40 orders of magnitude.

A.2. The nuclear interaction problem

Actually, the fusion process takes place in three steps:

i) the formation of an “hot”, highly excited ${}^4\text{He}$ nucleus:

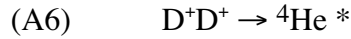

ii) its cooling to the ${}^4\text{He}$ fundamental state by transferring in a very short time ($< 10^{-21}$ s) the excess energy to the d-electron plasma[3,21]:

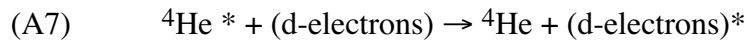

iii) finally the electron plasma releases its energy into the lattice through a multitude of elementary excitations ranging from soft X-rays to phonons:

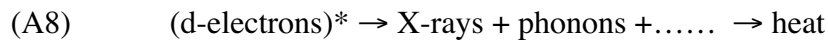

The difference between the fusion in vacuo and in condensed matter then becomes clear. In vacuo, because of the absence of a connecting medium as the e.m. field, the DD compound nucleus can only break into fragments according to (A3) and (A4). The probability that the ${}^4\text{He}$ nucleus does not break (by releasing its energy to a very hard γ -ray) is very small (10^{-6}).

In condensed matter the electromagnetic coupling with the d-electron plasma prevents the composite nucleus fragmentation and produces (almost) exclusively ${}^4\text{He}$. As a consequence we could expect that nuclear “microfurnaces” should appear in the sections of the one-dimensional cathode where the electric potential is most negative and according to the Preparata effect the loading is largest ($x > 1$). Since we expect, at this stage of the research, to be able to overcome the critical threshold by only a narrow margin, we anticipate the erratic appearance of “hot spots” where the temperature T can become very high (in a region having the size of a crystal grain, namely a few microns). In this case, a significant fraction of the energy output will be released in the form of radiations which will thermalize far from the cathode. The consequences of this high local T are the predominance of the radiative Stefan-Boltzmann channel in the heat release and the possible appearance on the cathode surface of film boiling which could open convective channels to heat dissipation. Furthermore ${}^4\text{He}$ produced in the “hot spots” will not be confined in the Pd lattice and should therefore be found almost exclusively in the gas evolving from the cell.

From our theoretical “prejudice” that almost all fusion occurring in the Pd lattice should produce ${}^4\text{He}$, we derive that the easiest way to evaluate the energy output is to count ${}^4\text{He}$ atoms in the cell gases. Apart from providing the proof of the presence of nuclear processes,

such "helium" calorimetry is most reliable since the erratic thermodynamic regime of the cell prevents any credible stationary calibration. A calibration in real time (isoperibolic calorimetry [9,10]) could be used but this technique is quite difficult when the cell temperature fluctuates. At this stage of the research we have chosen to couple to a reliable "helium" calorimetry a still unreliable thermal calorimetry which provides us only with an indicator that excess of heat is being generated by the cathode. The presence of a positive difference between the "helium" calorimetric and thermal calorimetric results would be a confirmation that a fraction of the output energy escapes the thermal calorimeter.

REFERENCES

1. M. Fleischmann, S.J. Pons, *J. of Electroanal. Chem.* **261**, 301 (1989).
2. "Farewell (not fond) to cold fusion", Editorial of *Nature* **344**, 365 (1990).
3. T. Bressani, E. Del Giudice, G. Preparata, *Nuovo Cimento* **101A**, 845 (1989).
4. G. Preparata, unpublished, see also Ref. 19.
5. R. Felici et al. *Rev. Sci. Inst.* **66**(5), 3344 (1995).
6. A. De Ninno, A. La Barbera, V. Violante, *Phys. Rev.* **B56**, 2417 (1997).
7. G. Bambakidis et al., *Phys. Rev.* **177**, 1044 (1969).
8. G. Preparata, *QED Coherence in Matter*, (World Scientific Singapore, 1995), see in particular ch. 8
9. M. Fleischmann et al., *J. of Electroanal. Chem.* **287**, 293 (1990).
10. G. Preparata M. Scorletti, M. Verpelli, *J. of Electroanal. Chem.* **411**, 9 (1996).
11. X.Z. Li et al. Proceedings of *8th International Conference on Cold Fusion, ICCF-8, Lerici 2000*, edited by F. Scaramuzzi (SIF Bologna 2000), Vol. 70, p. 123.
12. G. Alefeld and J. Volkl, *Hydrogen In Metals*, **Vol. I, II** (Springer-Verlag 1978).
13. A. Cöhn, *Z. Elektrochem.* **35**, 676 (1929).
14. M. Fleischmann, S. Pons, G. Preparata, *Nuovo Cimento* **105A**, 763 (1992).
15. B. Dandapani, M. Fleischmann, *J. of Electroanal. Chem.* **39**, 323 (1972).
16. R. Wisniewski, J. Rostocki, *Phys. Rev.* **B3**(2), 251 (1971).
17. A. Sievert, W. Danz: *Z. Physik. Chem.* **B38**, 61 (1937).

18. J.B. Huizenga, *Cold Fusion: The Scientific Fiasco Of The Century*, (Oxford University Press 1993).
19. M. Cola, E. Del Giudice, A. De Ninno, G. Preparata, Proceedings of *8th International Conference on Cold Fusion (ICCF-8)*, Lerici 2000, edited by F. Scaramuzzi (SIF Bologna 2000), **Vol. 70**, p. 349.
20. Y. Aharonov, D. Böhm, *Phys. Rev.* **11**, 485 (1959).
21. G. Preparata Proceedings of *5th International Conference on Cold Fusion (ICCF-5)*, Montecarlo - Monaco 1995, p. 265.

Edito dall' **ENEA**
Unità Comunicazione e Informazione
Lungotevere Grande Ammiraglio Thaon di Revel, 76 - 00196 Roma
Stampa: Centro Stampa Tecnografico - C. R. Frascati
www.enea.it

Finito di stampare nel mese di Novembre 2002